

STUDIOTWENTYSEVEN



POLUS 007 CHAIR BY **PIERRE AUGUSTIN ROSE**

FABRIC BY PIERRE FREY
SOLID SEMI-GLOSS OAK LEGS
PRODUCTION TIME 14-16 WEEKS
HANDCRAFTED IN FRANCE

IN H 36.2 W 24.4 D 23.2 SH 18.5
CM H 92 W 62 D 59 SH 47

NEW YORK MIAMI LONDON BY APPOINTMENT ONLY ENQUIRE@STUDIOTWENTYSEVEN.COM WWW.STUDIOTWENTYSEVEN.COM

STUDIOTWENTYSEVEN

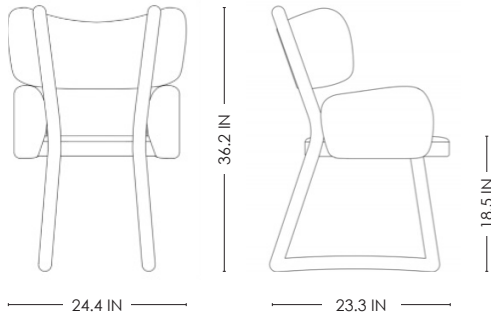

NATURAL LACQUER
OAK



BLACK LACQUER
OAK

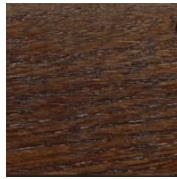

WALNUT LACQUER
OAK



MAHOGANY LACQUER
OAK